Simultaneous Optical and Laser Space Objects Tracking

M. Němec¹, I. Procházka¹, K. Hamal¹, G. Kirchner², F. Koidl², W. G. Voller²

1. Czech Technical University in Prague, Czech Republic
2. Satellite Laser Station Graz, Austrian Academy of Sciences, Austria

Contact: nemecm1@troja.fjfi.cvut.cz

Abstract

The goal of the presented experiments is the development of new optical tracking techniques for space objects, namely space debris, based on simultaneous CCD and laser measurements: the CCD tracking of a laser illuminated object, the simultaneous CCD tracking and laser ranging and the laser time-tagging of the CCD tracking. The first two experiments can be performed on cooperative - corner retro-reflectors equipped satellites while the third one is applicable to any space object and to space debris in particular. The high accuracy and density of laser ranging data and additional Time-tags in the CCD image, atmospherically back scattered photons, can contribute to the solution stability of computed orbits from data based even on a single tracking location within a single pass.

Simultaneous Optical and Laser
Space Objects Tracking

Goals

The goal of the presented experiments is the development of new optical tracking techniques of space objects, namely the space debris, based on simultaneous Optical detection (CCD tracking) and laser measurements:

- 1) the CCD tracking of laser illuminated object
- 2) the simultaneous CCD tracking and object laser ranging
- 3) the nanosecond laser time-tagging of the CCD tracking

The first two techniques can be performed on co-operative retroreflector equipped objects (high power lasers could be further used even for non co-operative [1]).

While the third one is applicable to any space object, the space debris in particular.

Add new applications for Satellite Laser Ranging stations

Martin Němec, FNSPE, CTU in Prague, nemecm1@troja.fjfi.cvut.cz

Classic optical detection

- Technique for determination the orbit of object, based on object's angular positions measurements
- Object illuminated only by Sun
- Telescope synchronized to catalogued stars + object in FOV during exposure -> angular coordinates -> pixels
- 2 Time-tags in the CCD image (Exposure start time and Exposure length) -> times -> pixels
- Problems of the accurate time-tags assigning to subpixels positions in the image (edges detections from signal curve with low SNR)

Object illuminated by Sun only

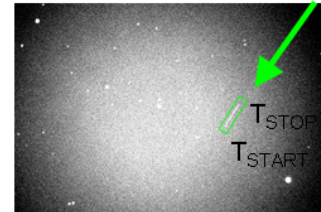

Laser usage in Optical detection:

- Additional object illumination
 - cooperative objects - Low power laser (usually stronger back reflections (retroreflectors nature) than by Sun only illumination)
 - noncooperative objects - High power laser (object shape reflectivity)
- Additional Time-tags in the CCD images – Low or High power laser
Time-tags with **nanosecond time precision and subpixel positions** by laser photons backscattered by atmosphere

Martin Němec, FNSPE, CTU in Prague, nemecm1@troja.fjfi.cvut.cz

High Precision 3D solution

Object laser ranging + Optical detection with laser time-tagging

- **cooperative objects**
 - Calibration of Optical detection systems
- **noncooperative objects**
 - High power laser strong to get enough returns -> Ranging results -> Orbit estimation
 - Low power laser (only few returns) -> combination of ranging data + high precision angular data (laser time-tagging) -> Orbit estimation

High Precision 2D solution

Optical detection with laser time-tagging

- **cooperative or noncooperative objects**
 - several times more of high precision angular data (laser time-tagging) -> Orbit estimation

Martin Němec, FNSPE, CTU in Prague, nemecm1@troja.fjfi.cvut.cz

Simultaneous Optical and Laser Space Objects Tracking

Project scheme

High Precision 3D solution

Optical detection with laser time-tagging

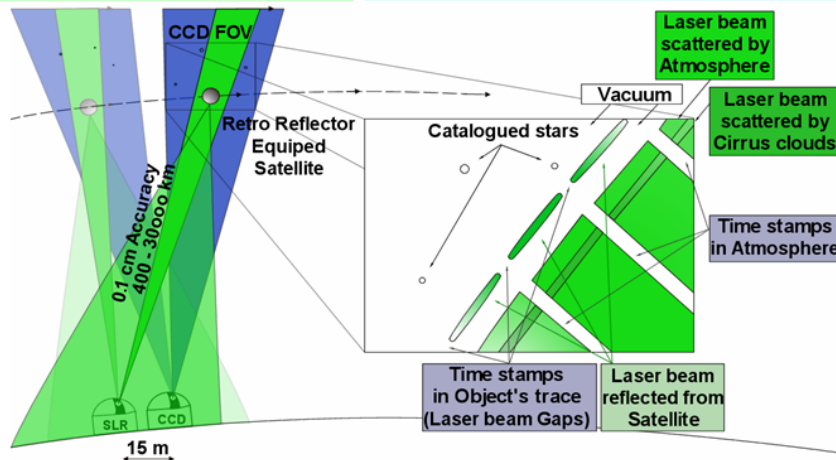

Observatory - Satellite laser ranging station in Graz, Austria



Martin Němec, FNSPE, CTU in Prague, nemecm1@troja.fjfi.cvut.cz

Simultaneous Optical and Laser Space Objects Tracking

Laser Time-Tags without returns

Classic optical detection

- Object illuminated by Sun only
- Only 2 Time-tags (Exposure start time and Exposure length) (more Time-tags using Advanced methods with e.g. rotating shutter)
- Times for Time-tags – millisecond up to microsecond scale (GPS)
- Problems of the accurate time-tags assigning to subpixels positions in the image (edges detections from signal curve with low SNR)
- Accuracy - up to 1 arcsecond
- Nr. of angular measurements during 1 path: usually ~ 10 values/path,

$$\max \sim \frac{\text{path time}}{\text{telescope positioning} + \text{exposure} + \text{image readout times}}$$

Optical detection with Laser Time-Tagging

- Object illuminated by Sun and partially by Low-power laser (or by High-power laser only)
- Basic 2 Time-tags (Exposure start time and Exposure length) + **more additional Time-tags** by laser beam modulation or by selection of pulses to be send to the object
- **Higher precision** of the Times for Time-tags – nanosecond scale
- **Higher accuracy** of time-tags assigning to subpixels positions in the image – All image area of Atmospherically back-scattered photons could be used - not only edges detections from signal curve
- Accuracy – **better than 1 arcsecond** (first results ~0.2 arcsec/s)
- Nr. of angular measurements during 1 path: **higher productivity**
Nr. of optical measurements × Nr. of laser time-tags in image

Object illuminated by Sun only

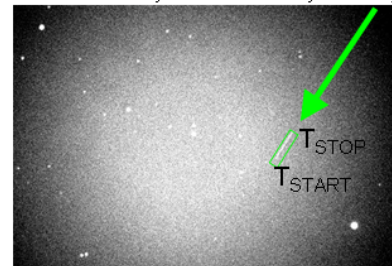

High Precision 2D solution

Laser beam reflected from satellite

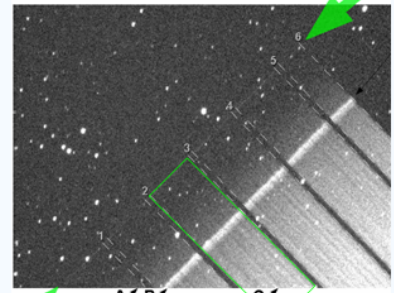

Lageos1 Cirrus clouds

1-5: Laser gaps = 10 Time-tags by laser beam photons backscattered from atmosphere

Simultaneous Optical and Laser
Space Objects Tracking

Experiment Setup (1/3)
SLR system

Satellite Laser Ranging System (SLR) station in Graz

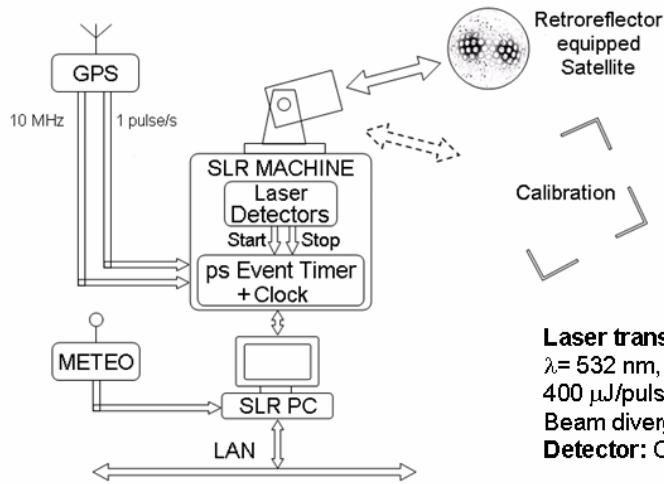

Ranging accuracy ~few mm
for Retroreflector equipped
satellites
in distances
of 400-30'000 km

Laser transmitter: HighQLaser, Diode pumped Nd:Van,
 $\lambda = 532$ nm, repetition rate 2 kHz, Pulse length 8 psec,
400 μ J/pulse, Average power up to 1W
Beam divergence $\theta \sim 100$ μ rad
Detector: C-SPAD; Range up to 30 000 km

The SLR station has been modified to provide laser power output modulation (selection of output pulses – gating of Pockel's cells) to serve as a time tagger for the laser illuminated exposures.

The laser is "switched off" for the preset time interval (e.g. 50, 100 or 500 milliseconds, etc.) each one second. The precision of the time-tags is on the nanosecond scale. The time scale accuracy connected to GPS is better than 100 ns.

Martin Němec, FNSPE, CTU in Prague, nemecm1@troja.fjfi.cvut.cz

Simultaneous Optical and Laser
Space Objects Tracking

Experiment Setup (2/3)
Telescope and CCD cameras
for Optical detection



CCD Telescope:

Meade LX200 16", f/10
Tracking precision 5 arcmin (worse now)

Focal reducers: f/6.3 or f/3.3

Field of View:

CCD1: ~ 23x15 arcmin, 1.8x1.8 arcsec/pixel (bin 3x3)
CCD2: ~ 16.6x12.5 arcmin, 1.2x1.2 arcsec/pixel (bin 2x2)
EMCCD: ~ 9.3x7.0 arcmin, 0.85x0.85 arcsec/pixel

(EMCCD = CCD with internal Electron multiplying register)



CCD cameras:

1: SBIG ST-10ME
Pixel Array: 2184x1472
Pixel Size: 6.8x6.8 μ m \times μ m
CCD Size: 14.9x10 mm \times mm

Filter:
488-574 nm, green pass

2: SBIG ST-2000XM
Pixel Array: 1600x1200
Pixel Size: 7.4x7.4 μ m \times μ m
CCD Size: 11.8x8.9 mm \times mm

Filter:
no filter

EMCCD camera:

Andor Luca^{EM}
Pixel Array: 658x496
Pixel Size: 10x10 μ m \times μ m
CCD Size: 6.58x4.96 mm \times mm

Filter:
no filter

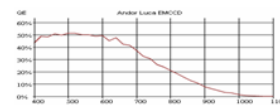
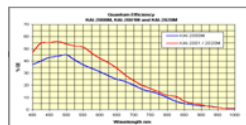
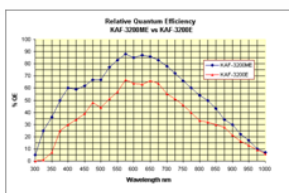
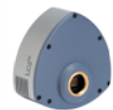

Martin Němec, FNSPE, CTU in Prague, nemecm1@troja.fjfi.cvut.cz

Simultaneous Optical and Laser Space Objects Tracking

High Precision 3D solution

1. Object path prediction
2. SLR Station:

Telescope - able smooth real-time object tracking (~ 1 arcsecond)

- diameter depending on object shape and reflectivity

Laser – pulse (min. repetition rate > 1 Hz (higher is better)

- depending on Optical detection system FOV, object speed and nr. of laser time-tags)

Pulses gating system + events timing system with high accuracy + [photon detector*](#)

[Sensitive camera – CCD, EMCCD, ISIT, etc. \(optical feedback\)](#)

3. Optical detection system:

Telescope

- object tracking precision (~ 5 arcminutes or better, depending on Optical det. system FOV)

- diameter depending on object shape and reflectivity

Sensitive Low-Noise Camera – CCD, EMCCD

- Pixel size, Quantum efficiency depending on object speed, shape and reflectivity
(+ telescope properties)

Experiment Setup (3/3) Minimal system configurations

High Precision 2D solution

* photon detector is not necessary

Martin Němec, FNSPE, CTU in Prague, nemecm1@troja.fjfi.cvut.cz

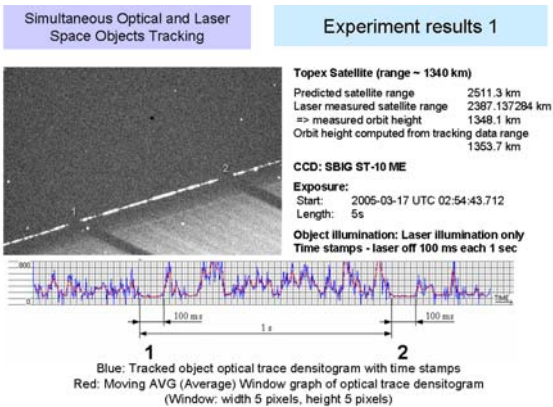

Martin Němec, FNSPE, CTU in Prague, nemecm1@troja.fjfi.cvut.cz

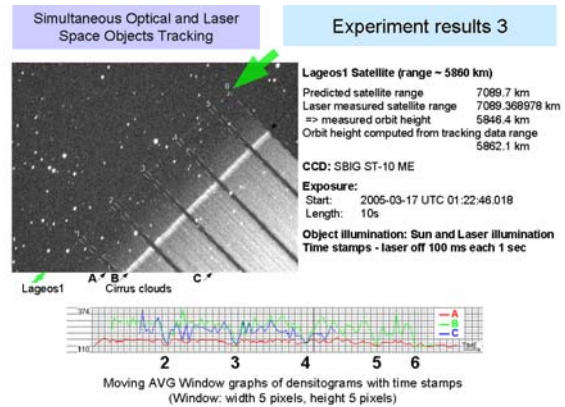

Martin Němec, FNSPE, CTU in Prague, nemecm1@troja.fjfi.cvut.cz

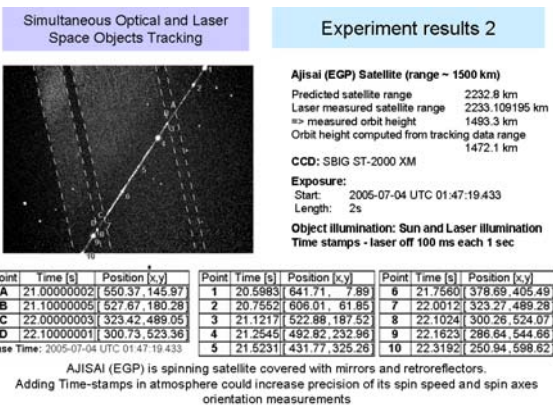

Martin Němec, FNSPE, CTU in Prague, nemecm1@troja.fjfi.cvut.cz

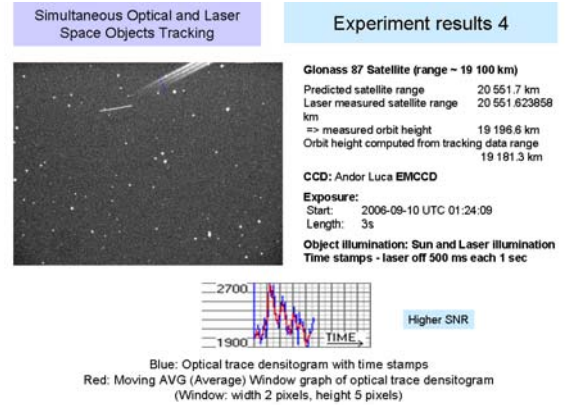

Martin Němec, FNSPE, CTU in Prague, nemecm1@troja.fjfi.cvut.cz

Atmosphere density – low density => less back-scattered photons

Object tracking Accuracy and Smoothness of the tracking laser movement

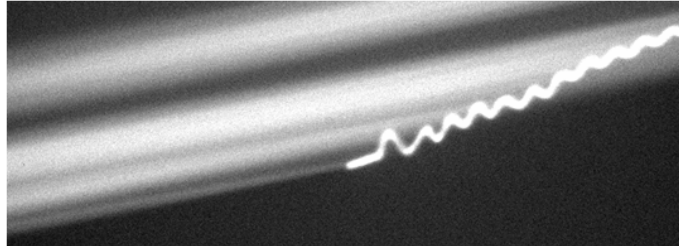

Distance between Laser and CCD telescopes

- too far => low back scattered photons
- too close => low tags resolution - merging

Position of Object, SLR station and CCD telescopes – “Blind Angles”



Martin Němec, FNSPE, CTU in Prague, nemecm1@troja.fjfi.cvut.cz

Results

The high accuracy and density of laser ranging data and / or additional precise laser Time-tags in the CCD image, the atmospherically back scattered photons, can contribute to the high solution stability of computed orbits from data based on a single tracking location within a single pass.

These facts can result in increase the observation productivity and orbit computation stability in comparison to the techniques used recently.

Cooperative targets tracking has been tested by our group in a series of experiments involving combined optical and laser tracking of space cooperative objects at the Observatory of Graz, Austria, March 15-17, 2005 and in September 2006. The laser time-tagging method was also tested on following satellites with retroreflectors: **Champ** (~ 400 km), **ERS2** (~ 800km), **GPS-35** (~ 20000 km).

Non-cooperative target tracking has been tested by B. Greene [1].

[1] B. Greene et. al., *Advanced Techniques at the EOS Space Research Centre*, 14th International Laser Ranging Workshop, San Fernando, Spain, June 7-11, 2004, published in Boletin ROA No. 4/2004, Real Instituto Observatorio de la Armada, en San Fernando, ISSN 1131-5040, 2004

Future

- Improvement of precision of the image processing methods (now under development)
- Method testing on non-cooperative objects
- Other image time-tagging methods development

Martin Němec, FNSPE, CTU in Prague, nemecm1@troja.fjfi.cvut.cz